

PowerBoss[®]
The Power of Clean

Scrubmaster AMR

User Manual



Contents

Introduction	6
Technical Specifications	8
Important Safety Instructions	9
Symbols and conventions in this document.	9
General safety	9
Environmental safety	9
Operational safety	10
Maintenance and service safety	11
Scrubber safety	11
Scrubmaster AMR Overview	12
How the Machine Works	15
Components Overview	16
Solution fill port and filter	16
Solution tank site gauge/drain hose	16
Warning light	16
Emergency stop	17
Start/pause.	17
Battery compartment	17
Recovery tank drain hose	18
Recovery tank screened float.	18
Operation seat/tank lid	18
Acceleration pedal.	19
Sensors.	19
Control Console Overview	20
User interface (UI) touch screen	20
Ignition key switch.	21
Horn button.	21
Solution tank low indicator	21
Recovery tank high indicator	21

Solution flow control.21
Direction buttons (forward/backward).22
Vacuum button.22
One-touch button22
Scrubmaster AMR Setup	23
Unpack Scrubmaster AMR23
Scrub brush/pad options24
Install scrub brush/pad25
Unload scrub brush/pad.25
Load scrub brush/pad25
Squeegee assembly26
Install and adjust squeegee.27
Install/replace squeegee blade.27
Adjust squeegee height27
Before Use	28
Manual Operation	29
Driving tips30
Double scrubbing in manual mode30
Autonomous Operation	31
Establish the home markers31
Robotic operations center.34
Pair a mobile device with the ROC35
Access the Learning Center.36
Teach an autonomous route37
Best practices when teaching a route37
Teach a new route38
Route management44
Delete a route46
Change a route label.47
Remove a route label48
Run an autonomous route.48

Contents

Best practices when running a route	48
Run one or more routes	49
Cancel a route	55
Manually stop the machine	56
Emergency Stop the machine.	57
Respond to notifications	58
Access the route history	58
Alerts during operation	60
Error codes and warnings	60
After Use	64
After use daily tasks.	64
Drain and clean tanks, hoses, and filters.	64
Clean scrub brush/pad	64
Clean squeegee	64
Clean in-line solution filter	65
Clean the sensors	66
Park and power down	68
Scrubmaster AMR storage	68
Battery Charging.	69
Battery charging	69
Brake Release	70
Brake release procedure	70
Troubleshooting & Support	71
Troubleshooting tips.	71
Maintenance & Support	73
Maintenance schedule	73
Where to get maintenance and support	74

Introduction

PowerBoss® Scrubmaster AMR description

This operator manual is provided with each new model and contains information to facilitate quick start-up of your new PowerBoss® Scrubmaster AMR, which this manual refers to as the *machine*. The machine is a commercial floor scrubber capable of manual and autonomous (self-driving) mode operation.

BrainOS is the name of the Brain Corporation artificial intelligence (AI) and autonomous navigation software that powers the autonomous operating capabilities of the machine. Use of autonomous operation requires a subscription to Brain Corporation Autonomy Services.

The machine is covered by one or more patents or pending patent applications. For details, see <https://www.braincorp.com/patents>. Discrete portions of this product were made possible by open source software. For details, see <https://www.braincorp.com/open-source-attributions>.

Intended use and precautions

The machine is intended for supervised commercial use. Use the machine exclusively on hard floors in an indoor environment. Do not use on soil, grass, artificial turf, or carpeted surfaces. Only use the machine with accessories approved by Brain Corporation or PowerBoss®. The machine must only be used by operators trained by Brain Corporation or Brain Corporation-approved trainers in a controlled, restricted environment approved by Brain Corporation.

Follow all provided instructions and warnings. Failure to adhere to the directions could result in damage to the machine and injury to the operator and public.

Additional training materials detailing the intended use of the machine might be provided, and must only be used in accordance with such training. Use the machine in approved environments in compliance with the Autonomy Services Agreement and the Autonomous Navigation Software End User License Agreement (EULA).

The operator is responsible for the use of the machine in both manual and autonomous operation. Therefore, each operator must be mindful to use the machine in accordance with its intended use, following precautions and warnings at all times. Operators must not engage in any of the following conduct or activities with respect to Autonomy Services or BrainOS:

- Transmission of any software or other materials that contain any viruses, worms, Trojan horses, defects, spyware, spiders, screen-scrapers, or other items of a destructive or disruptive nature.
- Exploitation of the Autonomy Services, BrainOS, or the machine hardware in any unauthorized manner, including trespassing or burdening server or network capacity or infrastructure.
- Framing, mirroring, or reselling any part of the Autonomy Services or the BrainOS software without Brain Corporation prior written authorization.
- Unauthorized collection of user information.
- Attempting to deliberately damage or undermine the legitimate operation of the Autonomy Services or BrainOS.
- The on-board cameras of the machine can capture images of people within its vicinity. Although the BrainOS software includes face-blurring capabilities that cannot be disabled, there may be additional jurisdictional laws of operation relating to use of technology with cameras. Comply with all applicable laws, including the use of signs or obtaining consent as required.
- Read completely and understand this manual before operating or servicing the machine.
- This machine offers superior service and delivers the best results when it is:
 - Operated with reasonable care.
 - Appropriately and regularly maintained, per the instructions provided.
 - Used with recommended accessories, such as approved squeegee blades, scrub brushes, pads, and so on.

Definitions, acronymns, and abbreviations

Table 1 lists terms used in this document.

Table 1: Definitions, Acronyms, and Abbreviations

TERM	DEFINITION
AGM	Absorbent glass material, an advanced battery technology
AI	Artificial intelligence
BrainOS	Brain Corporation operating system, the built-in navigational software
EULA	End User License Agreement
LIDAR	Light detection and ranging, used for two of the built-in sensors
LTE	Long-Term Evolution, the built-in modem connection method
ROC	Robotic Operations Center
UI	User interface

This document is subject to periodic updates and revisions.

Technical Specifications

MODEL	AUTONOMOUS MAX RIDE 20 (MR20-AI SERIES)
DIMENSIONS WITH SQUEEGEE	56 IN LENGTH X 29 IN WIDTH X 45 IN HEIGHT (142.24 CM X 73.66 CM X 114.3 CM)
WEIGHT	342 LBS (155.13 KG)
WEIGHT WITH BATTERIES AND FULL SOLUTION	691 LBS (313.43 KG)
SOLUTION TANK CAPACITY	16 GAL (60 L)
CLEANING PATH WIDTH	20 IN (50.8 CM)
SQUEEGEE WIDTH	25 IN (63.5 CM)
MINIMUM TURN AROUND AISLE WIDTH	54 IN (137.16 CM)
MAXIMUM MANUAL PRODUCTIVITY RATE	24,500 FT ² \HR (2276 M ² \HR)
MAXIMUM AUTONOMOUS PRODUCTIVITY RATE	20,400 FT ² \HR (1895 M ² \HR)
MAXIMUM MANUAL SPEED	3 MPH (4.8 KPH)
MAXIMUM AUTONOMOUS SPEED	1.5 MPH (2.4 KPH)
SCRUB HEAD TYPE	DISC
BRUSH PRESSURE	FLOATING - LOCKED
BRUSH MOTOR	400-600 WATTS
BRUSH SPEED	180 RPM
SOLUTION FLOW (LOW TO HIGH)	0-0.4 GPM (0-1.5 LPM)
VACUUM MOTOR	550 WATTS
VACUUM AIRFLOW	69 CFM (32.56 L\SEC)
VACUUM WATERLIFT	68 IN H ₂ O (172.72 CM H ₂ O)
SOUND PRESSURE\DECIBEL RATING	68 DBA
BATTERIES	(2) 12V 234Ah AGM SEALED, MAINTENANCE-FREE
BATTERY CHARGER	OFFBOARD/SHELF
MAXIMUM RUN TIME	3.30 - 4 HOURS
MACHINE VOLTAGE	24 VDC
MAXIMUM INCLINE/DECLINE GRADE LEVEL	0% ROBOTIC, 2% MANUAL
APPROVALS	NONE
IP PROTECTION CLASS	IPX4

Symbols and conventions in this document



Pay special attention when this symbol appears in this document:

DANGER or WARNING: Notification of hazards or unsafe practices that could result in physical or property damage, physical injury, or death.

General safety

The PowerBoss® Scrubmaster AMR is designed solely for scrubbing dirt and dust in a commercial, indoor environment. Do not use this Scrubmaster AMR in any other capacity. The following situations could cause injury to the operator and/or Scrubmaster 20. Read this manual carefully and use caution when these conditions exist.

- Operators must be appropriately trained on the use of the Scrubmaster AMR.
- Operators must read and understand this manual before operating or maintaining the Scrubmaster AMR.
- Train all personnel who will be operating the Scrubmaster AMR. The Scrubmaster AMR is not intended for users with reduced physical, sensory, or mental capabilities, nor by untrained users.
- Report any damage or faulty operation immediately. Do not use the Scrubmaster AMR if it is damaged in any way.
- Avoid moving parts.
- Do not allow children to play with the Scrubmaster AMR.
- Do not use the Scrubmaster AMR in a manner other than what is described in this manual.
- Do not clean with a pressure washer.
- Only plug the external charger into an outlet with an appropriate electrical rating: 100 to 240V, 50/60 Hz, 8 A. In North America, the standard grounded outlet emits 120V, which is in the appropriate electrical rating.
- Do not disconnect the offboard charger's DC cord from the machine's receptacle when the charger is operating. Arcing may result. If battery charging must be interrupted, disconnect the AC power supply cord first.
- Do not pull on the battery charger cord to unplug. Grasp plug at outlet and pull.
- Only use approved batteries and chargers. Use of unapproved parts may impair safety and potentially damage the machine and/or cause a fire.

Environmental safety

- The Scrubmaster AMR is not designed or intended for use in environments requiring fail-safe performance including, but not limited to any application in which failure of the Scrubmaster AMR could lead directly to death, personal injury, or severe physical or property damage.
- Do not use on soil, grass, artificial turf, or carpeted surfaces.
- Indoor use only.
- Do not use on public paths or roads.
- The Scrubmaster AMR should only be used to scrub flat, hard surfaces with little to no inclines (up to 2% incline when operating in manual mode; 0% incline when operating in robotic mode).
- All drops, stairs, escalators, moving platforms, or cliffs near the Scrubmaster AMR must be guarded by a physical barrier when operating in robotic mode.

Important Safety Instructions

- Do not use temporary elevated platforms (e.g. ladders or scaffolds) near the Scrubmaster AMR during operation.
- Do not leave electrical cords or low-profile items (e.g. items with a height of less than 7 inches [18 centimeters] from the ground) in the Scrubmaster AMR's area of operation.
- Place Wet Floor signs in areas where the Scrubmaster AMR is operating. See the ASA and EULA for further uses and restrictions.
- Operating and storage temperature is 35°F - 100°F (2°C - 38°C).
- Store indoors in a dry environment.
- Use caution when moving the Scrubmaster AMR into or out of areas that are below freezing temperatures. Any water in the tanks or hoses can cause damage to the Scrubmaster AMR.
- Park and store the Scrubmaster AMR on a level surface only.
- Some objects may be difficult for the Scrubmaster AMR to detect, such as diffusive black finishes, highly polished/reflective surfaces, or Plexiglas. Avoid cleaning in robotic mode where these objects are present.
- Avoid using the Scrubmaster AMR in proximity to other products that are sensitive to electromagnetic noise.
- Do not use in low traction environments (e.g. ice, oil, etc.).
- Avoid use in environments where stopping could result in a safety risk, such as blocking an emergency exit.
- Avoid use in environments with inconsistent terrain texture (excessively bumpy) or many floor transitions.
- Only use approved batteries and chargers. Use of unapproved parts could impair safety and potentially damage the machine or cause a fire.

Operational safety

- Keep hands and feet clear of moving parts while the Scrubmaster AMR is in operation.
- Locate and make sure all safety devices (e.g. operator seat sensor, yellow safety straps, and emergency stop buttons) are in place and fully functional.
- All doors and covers must be positioned as indicated in the instruction manual before using the Scrubmaster AMR.
- Keep all third parties, especially children and animals, at least 3 feet away from the machine during operation.
- The operator is responsible for supervising and monitoring safe operation of the Scrubmaster AMR.
- Do not ride the Scrubmaster AMR when it is operating in robotic mode.
- Do not grab the steering wheel when operating in robotic mode, as it may move rapidly and unexpectedly.
- All wheels/tires always need to be in contact with the floor. Avoid abrupt maneuvers while using in manual mode.
- Do not use flammable cleaning agents.
- Do not operate the Scrubmaster AMR near flammable materials such as solvents, thinners, fuels, grain dust, etc. Electric motors and components can cause an explosion when operated near explosive materials or vapors.
- The Scrubmaster AMR is not suitable for picking up hazardous substances.
- Use appropriate personal protective equipment, as recommended by the cleaning chemical safety data sheet, when adding cleaning chemicals or draining fluids.
- Observe the legal directives and local regulations for disposal of cleaning chemicals or detergents.
- In case of accidental contact or spillage of cleaning chemicals or detergents, follow guidelines provided by the manufacturer.

Important Safety Instructions

- Only use the brush/pad provided with the Scrubmaster AMR or those specified by Brain Corp or PowerBoss. Use of unauthorized brushes/pads may impair safety and potentially damage the Scrubmaster AMR.
- Do not leave the Scrubmaster AMR unattended without first turning the ignition key off and removing the key. When the Scrubmaster AMR is operating in robotic mode, remove the ignition key to prevent unauthorized use.
- Drain all tanks and hoses prior to storing the Scrubmaster AMR.
- Prevent unauthorized use of the Scrubmaster AMR by storing with the ignition key removed.
- Do not charge batteries when open flames or sparks are present. Do not smoke.
- If the battery charger or power supply cord is damaged, it must be replaced. Do not use damaged parts.

Maintenance and service safety

- Repairs and specified maintenance tasks must be performed by authorized personnel only.
- Only use approved replacement parts. Use of unapproved parts may impair safety and potentially damage the machine.
- Read all instructions before performing any service or maintenance function.
- Take precautions to prevent hair, jewelry, or loose clothing from becoming caught in moving parts.
- Only work on the machine when it is parked on a level surface and appropriately stabilized via safety blocks or support stands, if necessary.
- Do not lay tools or metal objects on top of the batteries.
- Remove all jewelry, watches, and other conductive materials when working near electrical components.
- Dispose of depleted batteries that can no longer be recharged in accordance with your local environmental regulations.

Scrubber safety

- Place wet floor signs in areas where the machine is operating. See the Autonomy Services Agreement and the End User License Agreement (EULA) for further uses and restrictions.
- Use caution when moving the machine in or out of areas below freezing temperatures. Frozen water in the tanks or hoses could damage the machine.
- Use the correct personal protective equipment—as recommended by the cleaning chemical safety data sheet—when adding cleaning chemicals or draining fluids.
- Observe the legal directives and local regulations for disposal of cleaning chemicals or detergents.
- In the event of accidental contact or spill of cleaning chemicals or detergents, follow the guidelines provided by the manufacturer.
- Only use brushes or pads provided with the machine or those specified by Brain Corporation or PowerBoss. Use of unauthorized brushes or pads could impair safety and potentially damage the machine.
- Do not use flammable cleaning agents.
- Drain all tanks and hoses prior to storing the machine.

Scrubmaster AMR Overview



1. Sensors: Side 2D Cameras
2. Sensors: Front 2D Camera
3. Sensors: Front 3D Camera
4. Sensors: Side 3D Cameras
5. Sensors: Lower LIDAR
6. Front Bumper Skirt
7. Front Drive Wheel
8. Scrub Deck
9. Squeegee
10. Accelerator Pedal
11. Solution/Recovery Tank
12. Operator Seat/Recovery Tank Lid
13. Sensors: Upper LIDAR

Scrubmaster AMR Overview

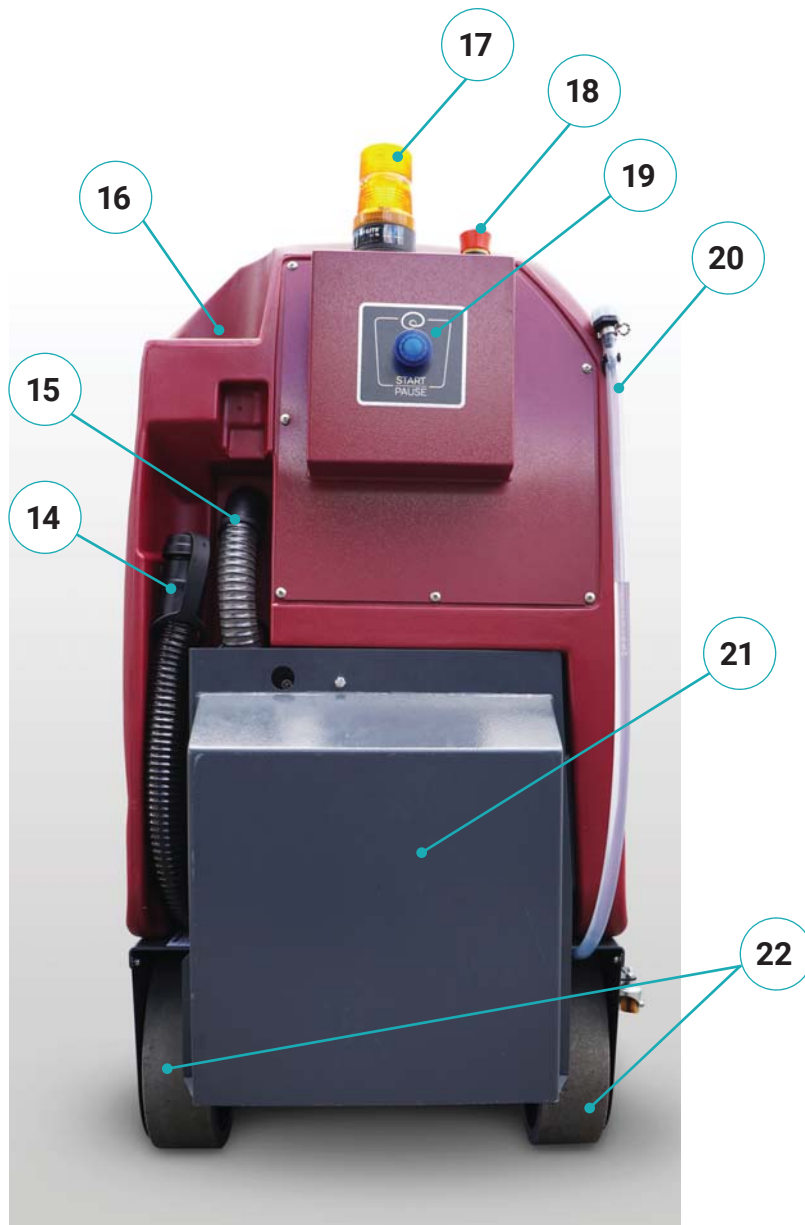

- 14. Recovery Tank Drain Hose
- 15. Vacuum Motor Muffler
- 16. Solution Fill Port
- 17. Warning Light
- 18. Rear Emergency Stop
- 19. Start/Pause Button
- 20. Solution Tank Site Gauge/Drain Hose
- 21. Battery Compartment
- 22. Rear Tires

Scrubmaster AMR Overview



- 23. Ignition Key Switch
- 24. User Interface (UI) Touch Screen
- 25. Steering Wheel
- 26. Front Emergency Stop
- 27. Horn Button
- 28. Recovery Tank High Indicator
- 29. Solution Tank Low Indicator
- 30. Solution Flow Control
- 31. One-Touch Button
- 32. Vacuum Button
- 33. Direction Buttons (Forward/Backward)

How the machine works

The machine is capable of manual and autonomous operation, thanks to BrainOS technology. A subscription to Brain Corporation Autonomy Services is required to use autonomous operation.

The machine consists of a solution bottle, clean water tank, scrub brushes or pads, squeegees, vacuum fan, and a recovery tank to provide efficient floor scrubbing. The vacuum button turns the vacuum on and off and raises or lowers the squeegees. The One-Touch button engages the solution, clean water, vacuum, scrub brushes or pads, and squeegees with a single press. Settings on the control panel configure the solution flow, water flow, and brush pressure levels. This provides customized cleaning based on the current cleaning needs.

The directional switch and steering wheel determine the direction the machine travels, while the accelerator pedal controls the speed of the machine. Releasing pressure from the accelerator pedal causes the machine to stop. Pressing the brake pedal immediately stops the machine.

The machine is equipped with BrainOS software accessed from the user interface (UI) screen. BrainOS technology offers an autonomous operation feature that provides the ability for the machine to perform floor cleaning by following one of the saved cleaning routes without direct, real-time operator control. The machine can only operate in autonomous mode in areas where cleaning routes have been taught and saved. It allows an operator to teach the scrubber new cleaning routes, run existing cleaning routes during autonomous operation, and access triggered alert messages and notifications. It also provides constant visibility to the current battery life, number of hours the machine has operated, and the Robotic Operations Center (ROC) connection status.

The machine is also equipped with light radar (LIDAR) sensors, 2D cameras, and 3D cameras, all of which work together to provide a 270° field of vision for the autonomous software. All sensors and cameras constantly survey the machine surroundings for both stationary and moving obstacles. When an obstacle is detected, the machine attempts to navigate around it and continue on its autonomous route.

Home Markers (see “Establish the Home Markers” section) must be permanently installed before the machine can operate in autonomous mode. A Home Marker is a unique scan code identifier—like a QR code—the machine scans to determine its current location, and any routes that have been saved to (or associated with) that specific Home Marker. The machine works with up to 10 Home Markers. Each Home Marker can store up to 6 routes for a total of 60 routes.

When operated in manual mode, the solution and clean water are dispensed on the floor as the machine is driven. The scrub brushes or pads scrub this combination as the machine travels forward. The side squeegees help control the path of the fluids. The rear squeegee collects the dirty water. The vacuum picks up this dirty water and directs it to the recovery tank.

When operating in double scrubbing mode (see “Double scrubbing in manual mode” section), solution and clean water are dispensed on the floor as the machine is manually driven. The scrub brushes or pads scrub this combination as the machine travels forward. However, the squeegees and vacuum are not engaged when double scrubbing. This allows the cleaning solution to remain on the floor longer for a deeper clean.

Components Overview

Components overview

There are a number of physical components that play a vital role in floor scrubbing, as well as robotic operation. Familiarize yourself with all components and controls before using the Scrubmaster AMR.

Solution fill port and filter



The solution fill port is where you pour a premixed solution of an approved cleaning chemical and clean water. The solution tank can hold up to 18 gallons (68 liters). Use appropriate personal protective equipment and pour the premixed solution into the solution fill port. Use the solution tank site gauge to guide you as you pour. Do not overfill.

Solution tank site gauge/drain hose



The solution tank site gauge/drain hose serves two purposes: as a visual indicator of the solution tank volume and is used to drain the solution tank. Using appropriate personal protective equipment, drain the solution tank by removing the hose from the clip, removing the cap at the top of the hose, and lowering the hose to drain.

Warning light



The warning light flashes when the Scrubmaster AMR is operating in robotic mode. This serves as an indicator to passersby that the Scrubmaster AMR is currently in operation.

Emergency stop



The Scrubmaster AMR is equipped with two emergency stop buttons, one on the rear and one on the control console. The emergency stop buttons should only be used in emergency situations, as this potentially releases all fluids onto the floor causing a slipping hazard. When one of the emergency stop buttons is pressed, all scrubber functions are immediately stopped and the in-process robotic route is terminated.

Start/pause



The Scrubmaster AMR is equipped with a blue start/pause button on the back that is used to begin running a saved route in robotic mode, or to pause an in-process robotic route. When pressed, the scrub brush raises. The squeegee stays down and the vacuum remains on for approximately 20 seconds, after which the vacuum turns off and the squeegee raises. Always use the start/pause button to pause a robotic route for standard, non-emergency situations.

Battery compartment



The battery compartment houses the batteries, battery connections, and the onboard charger. See [UNPACK Scrubmaster AMR](#) and [BATTERY CHARGING](#) for details.

Components Overview

Recovery tank drain hose



The recovery tank drain hose is used to drain the recovery tank. Use appropriate personal protective equipment to drain the recovery tank by removing the hose from the clip, removing the cap at the top of the hose, and lowering the hose to drain.

Recovery tank screened float



Inside the recovery tank is a screened float. When the recovery tank is overfilled or a large amount of foaming is present, the screened float blocks the vacuum intake inside the tank protecting the vacuum motor and internal electronics from water damage. It is essential to keep the screened float clean and functioning properly.

Operation seat/tank lid

The operator seat is equipped with two sensors: a pressure switch under the seat cushion to prevent joyriding during robotic operation, and two contact switches located on the back of the seat and the body of the Scrubmaster AMR. It also serves as the recovery tank lid.



Acceleration pedal



Pressing the accelerator pedal moves the Scrubmaster AMR forward or backwards, depending on which direction switch is selected on the control console. The amount of pressure placed on the accelerator pedal controls the speed. When pressure is completely removed, the electromagnetic brake automatically engages, stopping the Scrubmaster AMR.

Sensors



The Scrubmaster AMR is equipped with LIDAR, 3D and 2D cameras, all of which allow machine vision for the robotic software. All sensors and cameras constantly surveil the robot's surroundings for both stationary and moving obstacles. When an obstacle is detected, the Scrubmaster AMR will attempt to navigate around it and continue on its robotic map.

Control Console Overview

Control console overview

The PowerBoss® Scrubmaster AMR, powered by BrainOS, was designed with total operator ease of use in mind. All controls and components have been designed as a total system to efficiently clean dirty floors. The control console consists of the User Interface (UI) Touch Screen, also referred to as the UI or touch screen, and a number of manual controls.

Before using the Scrubmaster AMR, familiarize yourself with all components and controls.

User interface (UI) touch screen

The Scrubmaster AMR is equipped with BrainOS software that is accessible via the User Interface (UI) Touch Screen, located on the left side of the control console. BrainOS technology offers a robotic mode feature that provides the ability for the Scrubmaster AMR to perform floor cleaning by following one of the saved navigation routes without direct, real-time operator control. When the machine is turned on, the BrainOS software automatically initializes. After initialization, enter the 4-digit security PIN (1337) to access the BrainOS software and use its autonomous functionality.

Once the BrainOS software has initialized, it is ready for use. The top of the touch screen displays the current time, battery life, and ROC connection status. In addition, the touch screen allows an operator to run an existing cleaning route robotically, teach a new cleaning route, and access to a variety of settings. See [ROBOTIC OPERATION](#) for details.

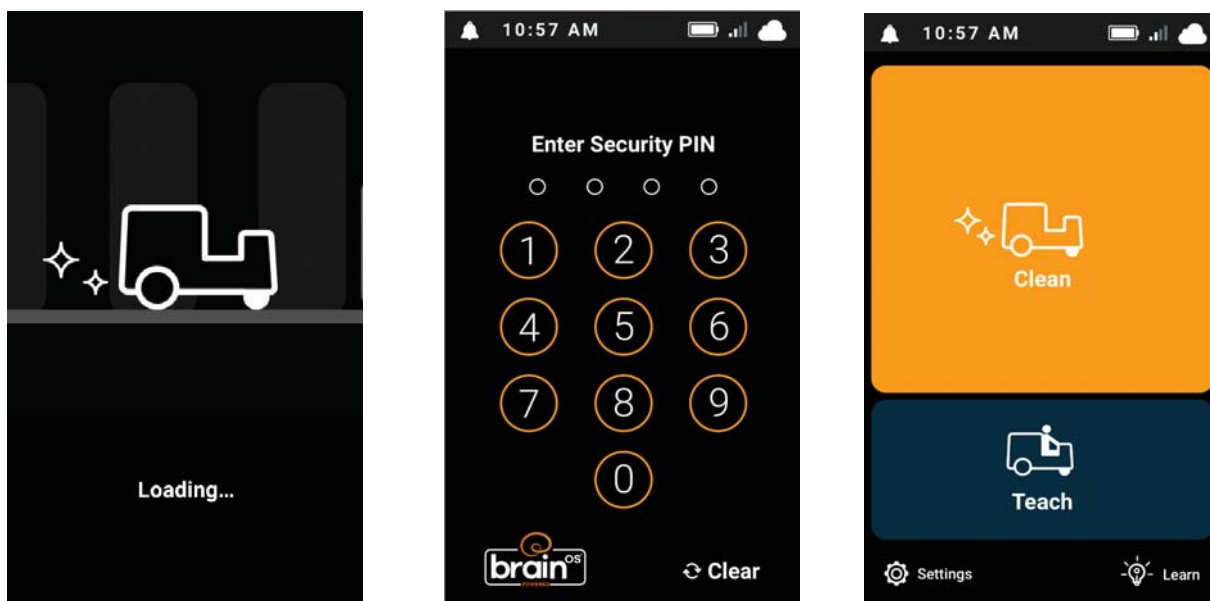

Figure 17: Screens from left-to-right: Startup, PIN entry, and the Main Menu

Ignition key switch



Just below the steering wheel is the ignition key switch. The ignition key switch turns the Scrubmaster AMR on and off. Turn the key to the right (clockwise) to turn on the Scrubmaster AMR. Turn the key to the left (counter-clockwise) to turn it off. In addition, the ignition key is used to unload the scrub brush when the key is turned to the left (counter-clockwise), past the off position. See [UNLOAD SCRUB BRUSH/PAD](#) for details.



Horn button

Pressing this button sounds the Scrubmaster AMR's horn.



Solution tank low indicator

When illuminated, indicates that the solution tank is low and needs to be refilled.



Recovery tank high indicator

When illuminated, indicates that the recovery tank level is high and needs to be emptied.



Solution flow control

The solution flow control regulates the amount of solution that is discharged during cleaning. This control returns to default factory settings (lowest setting) every time the Scrubmaster AMR is turned on, as cleaning needs may change from day-to-day. Before using, manually adjust the solution

flow control to the desired setting for optimum cleaning performance.

Control Console Overview

Direction buttons (forward/backward)



The direction buttons control whether the Scrubmaster AMR drives forward or backward when the accelerator pedal is pressed. The upward arrow instructs the Scrubmaster AMR to drive forward. The downward arrow instructs it to drive backward. When driving backward, the squeegee will automatically raise to prevent damage. Be sure to inspect the floor for any residual water after driving backward.



Vacuum button

Pressing the vacuum button turns the vacuum on. When the vacuum is turned on, the squeegee automatically lowers when driving forward. When the vacuum is turned off, the squeegee will stay down for approximately 8 seconds and then raise. The vacuum motor will run for approximately 15 seconds and then turn off.



One-touch button

The one-touch button engages the scrub brush, vacuum, and squeegee, allowing for immediate operation of the Scrubmaster AMR. When pressed, the scrub brush and squeegee are lowered, and the vacuum turns on. When scrubbing is complete, press the one-touch button again to disengage cleaning operations. The scrub brush will rise off the floor. The squeegee will remain down for a few seconds and then rise as well. After the squeegee has risen, the vacuum will remain on for a few additional seconds to clear any remaining water in the hose and then turn off.

Scrubmaster AMR Setup

Unpack Scrubmaster AMR

Check the packing crate for any damage, and immediately report any damage to the delivery carrier. To unpack the crate:

1. Remove plastic.
2. Remove box containing all robotic (autonomous) equipment and review contents to ensure all items are included.
3. Remove the walls from the pallet.
4. Remove the battery cover located on the back of the Scrubmaster AMR.
5. The Scrubmaster AMR is battery-operated and designed to operate on 24 volts DC; (2) 12 volt batteries. If necessary, insert both batteries.

**Recommended Battery Specifications: (2) 12 V
Discover Dry Cell Traction Valve Regulated Battery,
Model EV185A-A**

NOTE: PowerBoss recommends that only trained field technicians or maintenance staff install or replace batteries. Improper battery installation can cause risk to users and the machine.

6. Remove the tape from the two red battery connectors and attach them together.
7. Place the battery compartment cover back in position.
8. Remove the chock strips, squeegee straps, and straps needed to secure the ramp.

9. Remove the ramp attached to the back of the pallet.
10. Use the supplied straps to secure the ramp to the rear of the pallet.
11. Make sure the area behind the pallet is clear.
12. Remove the key that is strapped to the steering wheel.
13. Sit on the operator seat, insert the ignition key and turn to the right (clockwise) to start the Scrubmaster AMR.
14. Make sure the squeegee and scrub deck are raised.
15. Press the downward direction button arrow.
16. Slowly drive the machine backwards off the ramp.

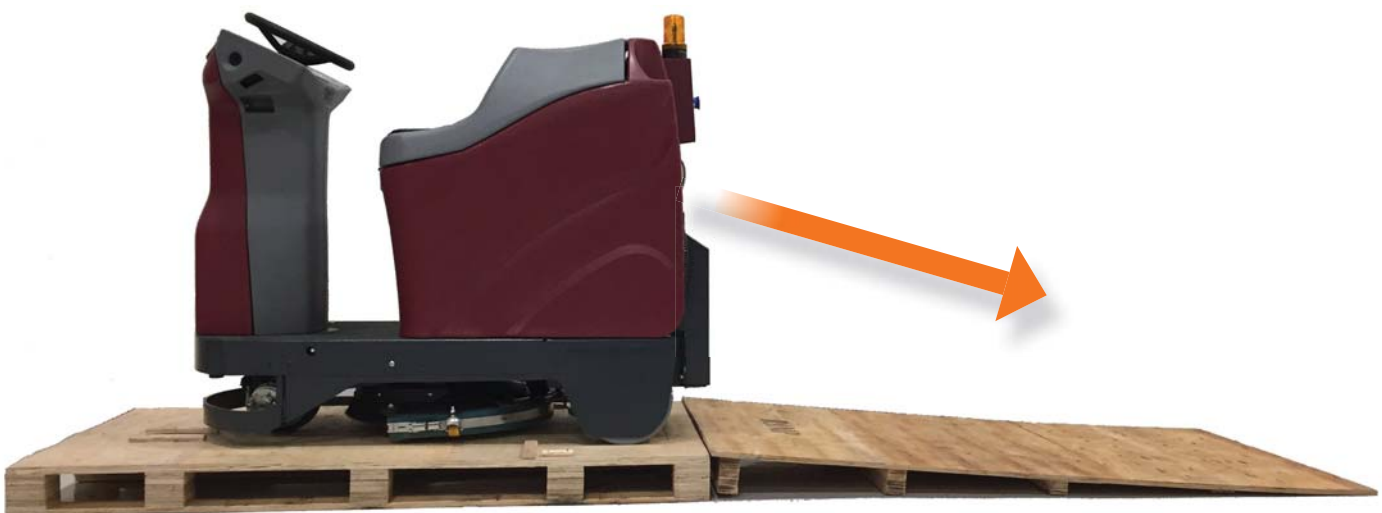

Scrubmaster AMR Setup

Scrub brush/pad options

The following scrub brush or pad options are available with the PowerBoss® Scrubmaster AMR, powered by BrainOS:

PART #	DESCRIPTION
172520-1	BRUSH-DISC, 20" NYLON, BLACK
172520-3	BRUSH-DISC, 20" NYLO-GRIT 80GR, BLACK
172520-6	BRUSH-DISC, 20" SCRUB GRIT 2, 120GR RED
172588	PAD DRIVER, ASSY, AQUASTOP, 20" (STANDARD)
762370	PAD RETAINER-REMOVABLE-NOT SHOWN
762394	PAD RETAINER-FIXED-NOT SHOWN
AQUASTOP BRUSHES	
7951-01	BRUSH, 20" LIGHT-MEDIUM PP.5 A/S, WHITE
7951-02	BRUSH, 20" LIGHT-MEDIUM A/S, K901, BLACK
7951-03	BRUSH, 20" MEDIUM NYLON 600GR A/S, GREY
7951-04	BRUSH, 20" MEDIUM-HEAVY PP.8 A/S, WHITE
7951-05	BRUSH, 20" HEAVY NYLON 180 GR A/S, GREY
7951-06	BRUSH, 20" HEAVY-2 NYLON 120GR A/S, GREEN

Install scrub brush/pad

The PowerBoss® Scrubmaster AMR, powered by BrainOS, is typically shipped with a scrub brush attached.

Unload scrub brush/pad

If there is a brush currently attached, perform the following steps to unload the scrub brush/pad:

1. Turn the ignition key to the left (counter-clockwise) to turn the Scrubmaster AMR off, if necessary.
2. Turn the ignition key to the left (counter-clockwise) past the off position and hold.
 - a. The scrub brush/pad will spin for a moment and then release.
 - b. Remove the scrub brush/pad from underneath the Scrubmaster AMR.
3. Turn the ignition key back to center position.

Load scrub brush/pad

Perform the following steps to load a scrub brush or pad:

1. Turn the ignition key to the right (clockwise) to turn on the Scrubmaster AMR.
2. Press the one-touch button to raise the scrub deck, if necessary.
3. Position the scrub brush or pad under the scrub deck.
4. Press the one-touch button to lower the scrub deck.
5. Once the scrub deck is completely lowered into position, lightly tap the accelerator pedal.
 - a. The scrub brush or pad will automatically load and lock into position.

Scrubmaster AMR Setup

Squeegee assembly

The PowerBoss® Scrubmaster AMR, powered by BrainOS, is equipped with a squeegee assembly that houses the squeegee blade. Familiarize yourself with all aspects of the squeegee assembly:

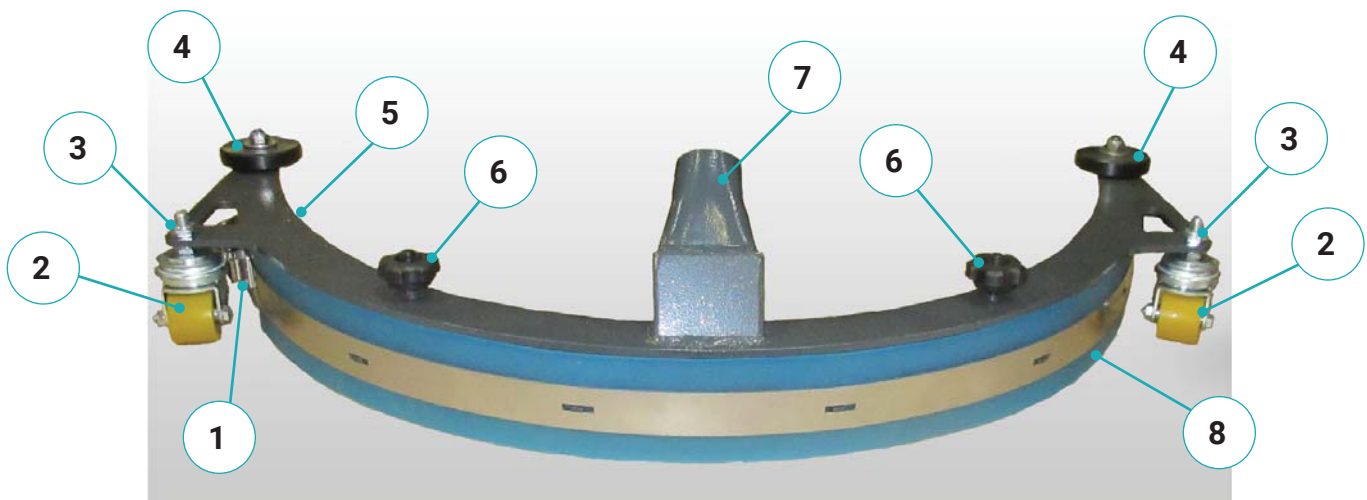

1. Outside Blade Fastening Latch
2. Caster Wheel
3. Nut for Squeegee Height Adjustment
4. Roller

5. Inside Blade Fastening Latch
6. 3-Sided Knob
7. Vacuum Connector
8. Squeegee Blade

Install and adjust squeegee

The PowerBoss® Scrubmaster AMR, powered by BrainOS, is typically shipped with the squeegee assembly attached.

Install/replace squeegee blade

If necessary, perform the following steps to install or replace a squeegee blade into the squeegee assembly:

1. Remove the squeegee assembly by pulling off the vacuum suction hose from the squeegee's vacuum connector.
2. Loosen both 3-sided knobs on the top of the assembly.
3. Remove the lower half of the squeegee assembly.
4. Unlock the inside and outside blade fastening latches of the squeegee blade.
5. Remove the squeegee blade, if present.
6. Insert the new squeegee blade.
7. Return and lock the inside and outside blade fastening latches.
8. Re-affix the lower half of the squeegee assembly to the upper half by tightening both 3-sided knobs on the top of the assembly.
9. Place the squeegee assembly underneath the Scrubmaster AMR.
10. Reattach the squeegee vacuum connector on the squeegee assembly to the vacuum suction hose underneath the Scrubmaster AMR.

Adjust squeegee height

The height of the squeegee is a direct result of the clearance between the caster wheels and the floor. If streaks are present, this clearance must be adjusted. To adjust the height of the squeegee, perform the following steps:

1. Locate the nut above the bracket that holds the caster wheel.
2. Adjust to the desired height by tightening or loosening this nut on both sides of the squeegee assembly.
 - a. The bottom of the squeegee blade should flare out slightly when the machine is moving forward.

Before Use

Pre-operation checks

The Scrubmaster AMR is capable of both manual and robotic operation, thanks to BrainOS technology. A subscription to Brain Corp's Autonomy Services is required to use the Scrubmaster AMR's robotic functions. Robotic mode means that the Scrubmaster AMR performs floor cleaning without direct, real-time operator control, which allows janitorial staff to focus on other tasks.

NOTE: The Scrubmaster AMR is a hard surface floor scrubber only, with no sweep functionality

Before using the Scrubmaster AMR, always perform the following checks to ensure proper operation:

- Clear all obstacles from the areas to be cleaned to ensure maximum floor coverage.
- Be sure you understand the functions of all components and controls.
- Check the horn, warning light, and front and rear signal lights to ensure proper operation.
- Check the Scrubmaster AMR for fluid leaks.
- Check the tank cover seal under the operator seat or damage and excessive wear.
- Drain and clean the recovery tank, if necessary.
- Clean and rinse the recovery tank screened float, if necessary.
- Drain and clean the solution tank, if necessary.
- Clean the solution fill filter, if necessary.
- Check the vacuum hose for debris or blockage; flush out any obstacles.
- Check the squeegee blade for damage, excessive wear, and deflection. Rotate or replace as needed.
- Check that the scrub brush/pad is properly installed and is clean of restricting debris, such as string, banding, plastic wrap, etc.
- Make sure the batteries are fully charged and free of damage.
- Check the brakes and steering to ensure proper operation.
- Check that all cameras and LIDARs are clean and free of dust, dirt, and smudges. Clean with the provided microfiber cloth, as needed.
- Using appropriate personal protective equipment, fill the solution tank with a pre-mixed solution of an approved cleaning chemical and clean water. Use the solution tank site gauge to guide while pouring. Do not overfill.
- Check that the audible cues can be heard for the Scrubmaster AMR.
- Place proper floor cleaning signage in areas where the Scrubmaster AMR is operating in accordance with standard floor cleaning practices.



WARNING: Do not put any flammable materials into the solution bottle or clean water tank. This can cause an explosion or fire.

Manual Operation

Before turning on the Scrubmaster AMR, make sure it is fully charged and free of damage. Perform the following steps to use the PowerBoss® Scrubmaster AMR manually:

1. Fill the solution tank via the solution fill port located on the top left corner of the back of the Scrubmaster AMR.



2. Ensure the operator seat is securely lowered with the two contact switches connected.
3. Sit on the operator seat.
4. Insert the ignition key and turn to the right (clockwise) to start the Scrubmaster AMR.
5. Wait for the screen to initialize.
6. Enter the 4-digit security PIN (1337) on the screen. Upon successful PIN entry, the screen displays the Main Menu.

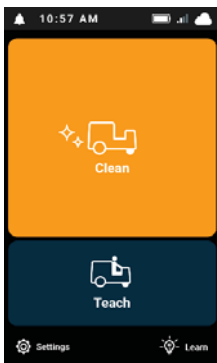

7. Press the one-touch button to engage the cleaning components (scrub brush and squeegee are lowered, and vacuum turns on).
8. Press the up or down direction button to determine whether you will be driving forward or backward.
9. Select the desired solution flow control setting.
10. Press the accelerator pedal to begin scrubbing. Similar to an automobile, the speed is proportional to the force applied to the pedal; light is slower, and heavy is faster.

NOTE: Complete removal of pressure from the accelerator pedal stops the machine. Press the brake pedal if faster stopping is required or if operating the machine on an incline or decline.

11. When finished scrubbing, remove pressure from the accelerator pedal and press the OneTouch button to disengage the cleaning components. The cleaning components turn off after a brief delay.

Manual Operation

Driving tips

- Drive in a straight path as much as possible.
- Drive slowly on inclines, declines, and slippery surfaces.
- Avoid inclines or declines greater than 2% when operating manually.
- Maintain a safe distance of approximately 18 in (46 cm) from the edge of ramps, platforms, cliffs, and glass.
- Avoid sudden turns or turning the steering wheel too sharply when driving.
- Use caution when driving backward.
- Report any damage to the machine prior to operation.

Double scrubbing in manual mode

When double scrubbing the machine scrubs the floor without removing the fluid from the floor surface. The squeegees and vacuum are not engaged during double scrubbing; only the scrub brushes and pads. This allows the cleaning solution to remain on the floor longer for a deeper clean.

NOTE: Double scrubbing is only available in manual mode. It must only be used in a controlled environment where there is no potential for slipping and falling.

To perform double scrubbing, follow these steps:

1. Fill the solution bottle and clean water tank.
2. Sit in the operator seat.
3. Turn on the machine.
4. Press the up arrow of the directional switch.
5. Press the One-Touch button to engage the cleaning components (scrub brushes, pads, squeegees, and the vacuum).
6. Press the vacuum button to turn off the vacuum. This also raises the squeegees off the floor.
7. Drive the machine along the preferred path for double scrubbing.
8. Let the cleaning solution set on the floor for approximately 5 minutes.
9. Press the One-Touch button to deactivate the scrub brushes or pads and solution flow.
10. Press the vacuum button to turn on the vacuum, which also lowers the squeegees to the floor.
11. Drive the machine along the same path to pick up the cleaning solution.

Autonomous operation

The machine is equipped with BrainOS technology that offers an autonomous operation feature. Autonomous operation provides the ability for the machine to clean floors by following one of the saved cleaning routes without direct, real-time operator control. The machine can only operate in autonomous mode in areas where cleaning routes have been taught and saved. BrainOS software is accessible from the screen, and provides access to teach a new cleaning route, run an existing route autonomously, access triggered alert messages, and more. The screen also provides constant visibility to the current battery life, the number of hours the machine has operated, and the ROC connection status.

Establish the home markers

Home Markers must be permanently installed before the machine can operate in autonomous operation. A Home Marker is a unique scan code identifier—like a QR code—that the machine scans to determine its current physical location, and any routes that have been saved to—or associated with—that specific Home Marker. The machine works with up to 10 Home Markers. Each Home Marker can store up to 6 routes for a total of 60 routes.



Figure 25: Home Marker

Home Markers establish the start and end point of a cleaning route. The number of Home Markers required depends on the size of the space in which the machine operates in autonomous operation.

- Multiple Home Markers might be required for large or unusually mapped areas where more than six cleaning routes are required.
- Establish a unique Home Marker for each floor of a multilevel building.
- Install Home Markers in a permanent location on an open, flat wall near commonly cleaned areas that do not change from day-to-day. If the Home Marker is moved even slightly, the route might not be followed correctly.
- Make sure the entire Home Marker is clearly visible, and not hidden behind furniture or shelving.
- Make sure there is adequate light for the camera to see the Home Marker, and that no shadows obscure the Home Marker.
- Do not install Home Markers near stairways, fire exits, or fire, first aid, or emergency equipment.
- Affix Home Markers securely to the wall so that the machine can easily scan them with the camera on its right side:

Autonomous Operation

- 40 in (100 cm) from the ground
- At a distance of no less than 24 in (61 cm)

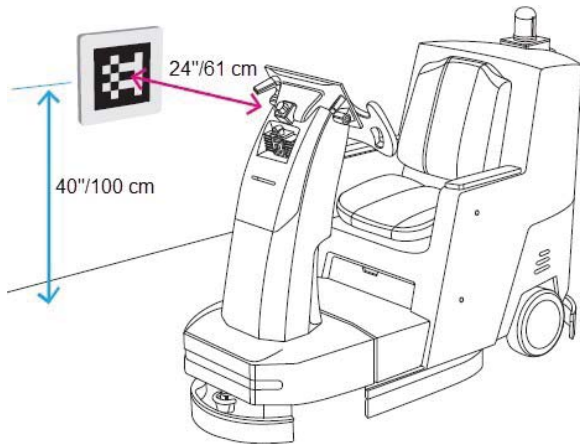

Figure 26: Home Marker distance and height measurements



Figure 27: Home Marker mounted on a wall

- After mounting, remove the protective film from the face of the Home Marker.
- Do not photocopy, laminate, or place Home Markers in a glossy sleeve or cover, which could prevent the machine from scanning the Home Marker.
- If a Home Marker is lost or damaged, contact customer service for a replacement.

Turn on the machine

To turn on the machine, follow these steps:



WARNING: Do not attempt to drive the machine while it is starting up.

1. To turn on the machine, insert the ignition key and turn to the right (clockwise). The screen briefly displays the BrainOS logo while the software loads, then displays the PIN entry screen.

NOTE: If the machine displays a startup error, see the OEM BrainOS Error Code Reference (150-00038-02) for details on troubleshooting the error.

2. Enter the 4-digit PIN (1337) on the screen.

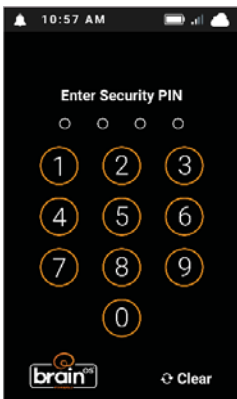

Figure 28: PIN entry screen

To improve machine effectiveness and efficiency, the machine displays proactive maintenance reminders on the user interface screen at the beginning of every power-on cycle.

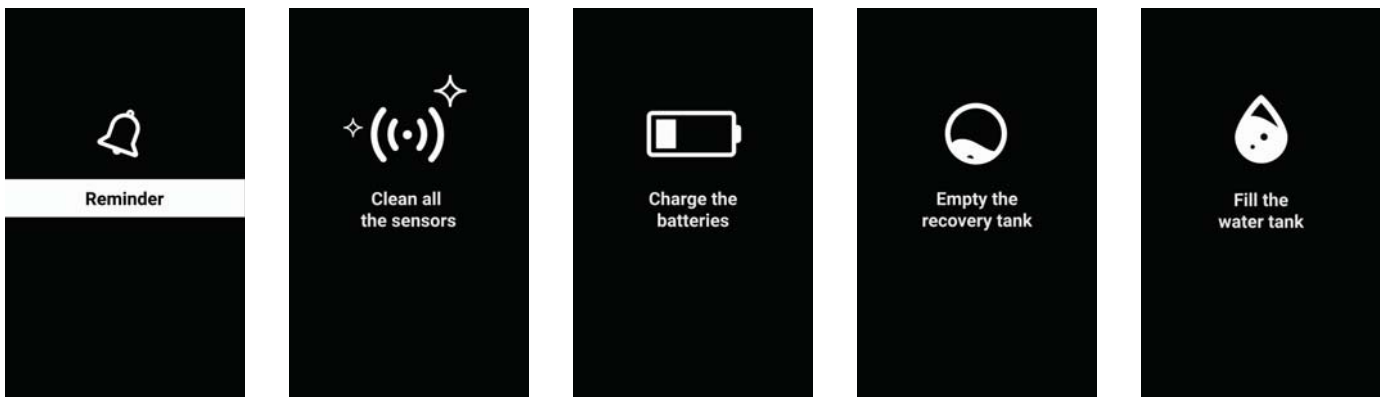

Figure 29: Maintenance reminder screen

3. Read and perform the instructions on the Reminder screen.
4. Once all of the reminders are shown, the screen will close automatically.

Autonomous Operation

The Main Menu displays the time, battery level, wireless signal strength, and the ROC synchronization status at the top of the screen.



Figure 30: Main Menu

Robotic operations center

BrainOS software provides access to the Brain Corporation Robotic Operations Center (ROC). The ROC is cloud-based and managed by Brain Corporation technicians. The ROC enhances the machine abilities by providing remote monitoring and analytics. The ROC is connected by a builtin fourth generation (4G) Long-Term Evolution (LTE) modem and does not require user action to connect. New versions of the BrainOS software automatically download to the machine without disrupting service or requiring operator interaction.

Figure 31 shows the ROC connection indicators seen at the top of the screen.

- When the machine is connected to the ROC, the screen displays the left icon.
- If the machine is not connected to the ROC, the screen displays the right (grayed out) icon. If the machine is not connected to the ROC, the ROC cannot be paired with a mobile device.

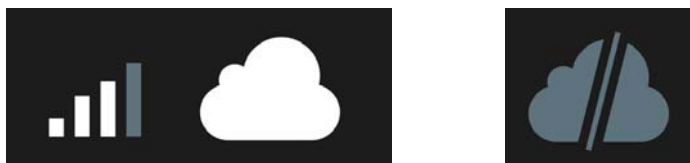

Figure 31: ROC connected (left) and not connected (right)

- If the machine is not connected to the ROC and a number displays next to the icon that number indicates how many items the machine needs to upload to the ROC. After the machine is connected to the ROC and uploads its items, the number disappears.

Pair a mobile device with the ROC

Before running an autonomous route, Brain Corporation recommends that the operator pair their mobile device with the ROC. After pairing, the ROC sends messages to the mobile device if the machine requires assistance and a notification when the cleaning routes are complete.

To make sure that only the on-site operator receives alerts from the ROC, only one mobile device can be paired with the ROC at a time. A paired mobile device is automatically disconnected when the machine is turned off or when a new mobile device is paired.

To pair a mobile device to the ROC, follow these steps:

1. To turn on the machine, insert the ignition key and turn to the right (clockwise).
2. Wait for the screen to initialize.
3. Enter the 4-digit PIN (1337) on the screen. Upon successful PIN entry, the screen displays the Main Menu.
4. From the Main Menu, select Settings.
5. Select Notifications.
6. To pair the mobile device with the ROC, follow the instructions on the screen.

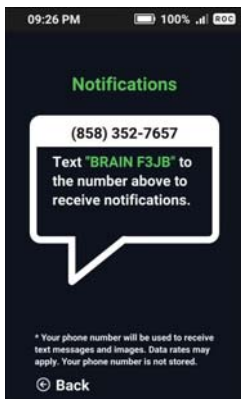

Figure 33: Send a text message to pair the mobile device with the ROC

Pairing is successful when the mobile device receives a confirmation text message.



Figure 34: Mobile device pairing confirmation

Autonomous Operation

Access the Learning Center

The Learning Center provides short, informative video tutorials in multiple languages that describe how to perform common tasks, such as:

- Home marker placement
- Train a new route
- Run an existing route

To access these tutorials, follow these steps:

1. To turn on the machine, insert the ignition key and turn to the right (clockwise).
2. Wait for the screen to initialize.
3. Enter the 4-digit PIN (1337) on the screen. Upon successful PIN entry, the screen displays the Main Menu.
4. From the Main Menu, select Learning Center.

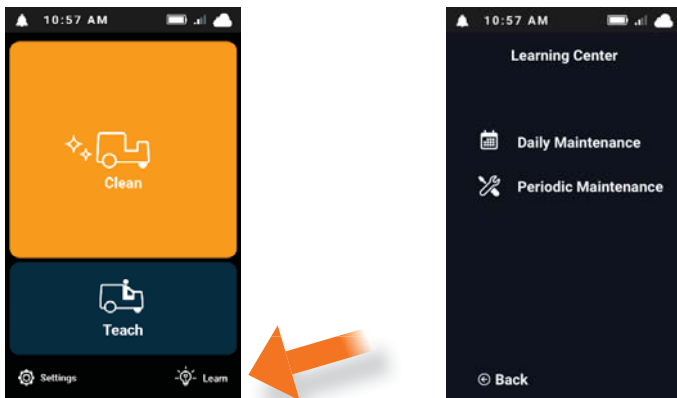

Figure 35: Access the Learning Center

5. Select the applicable video.
 - a. To pause the video, touch the screen.
 - b. To resume the video, touch the screen again.

Teach an autonomous route

The machine must be taught one or more cleaning routes before it can run in autonomous operation. The route is the precise path that the machine runs while in autonomous operation. New routes can be taught by deployment staff, supervisors, and operators. Proper planning and execution during this process is critical to the successful deployment of the machine. This process involves preparing the workspace for the route and driving the machine in a specific manner, as described below.

Best practices when teaching a route

- See the BrainOS-Powered Floor Scrubber Process Guide (139-00113-01) for detailed guidelines in different environments.
- Drive in a straight line as much as possible.
- Teach only flat routes with no inclines or declines.
- Try to limit each route to 45 minutes or less. Shorter routes allow more flexibility to change based on location traffic and conditions, but longer routes provide the operator a larger window of time to focus on other tasks. Shorter routes also make it easier to work with hightraffic areas that need more cleaning, and help to avoid low clean water and full waste water conditions during the route.
- Do not teach routes that include driving into an elevator or through automatic doors.
- Avoid sudden turns or turning the steering wheel too sharply when driving.
- Make smooth wide turns, avoid narrow aisles, and do not drive in reverse. For best performance, observe the turn restrictions for the machine, as defined in the operational manual for the machine.
- Because U-turns slow down the machine, circle around or alternate aisles wherever possible.
- Maintain a safe distance of approximately 1.5 ft (0.5 m) from the edge of ramps, platforms, cliffs, and glass. This includes escalators, elevators, and loading docks. Place a barrier or series of cones to prevent the machine from getting too close to these areas. The barrier or cones must measure at least 8 inches (20 cm) in height.
- Divide the space into contiguous routes for maximum efficiency and yield.
- Teach routes when the area is mostly clear of obstacles and people that could block the path of the machine. This might require teaching routes outside of normal run times.
- Optimize routes to account for other activities, such as restocking shelves.
- If a route is taught in an area with obstructions that are later removed, the machine does not clean any areas previously occupied by those obstructions.
- Reteach a route whenever the dimensions of the space change significantly or whenever new features have been introduced or removed—such as merchandise displays—or if there are performance issues with an existing route.

Autonomous Operation

Teach a new route

To teach a new route, follow these steps:

1. Sit in the operator seat.
2. To turn on the machine, insert the ignition key and turn to the right (clockwise).
3. Enter the 4-digit PIN (1337) on the screen. Upon successful PIN entry, the screen displays the Main Menu.
4. Select Teach Route.

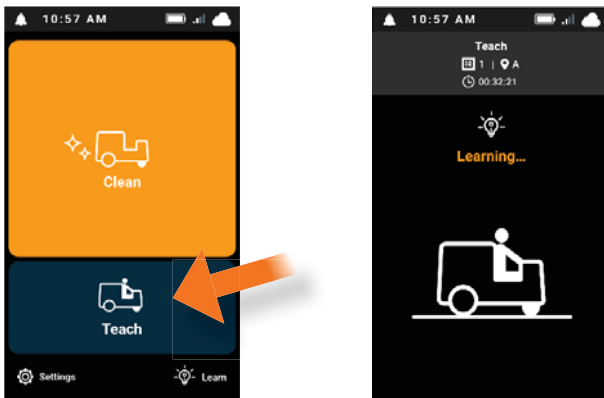

Figure 36: Teach a new route

The screen displays Drive to scan my home location.

5. Drive the machine to the correct Home Marker and position the machine so the right-side camera is approximately 2 ft (0.6 m) away. The machine automatically scans the Home Marker.



Figure 37: Scanning the Home Marker

NOTE: If the machine cannot scan the Home Marker, the screen displays an error message with instructions how to resolve the issue.

After the machine successfully scans the Home Marker, the confirmation message briefly displays on the screen, followed by the available route locations.

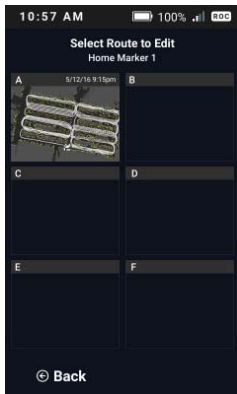

Figure 38: Select an undefined route

NOTE: If all six routes are already defined, an existing route must be deleted first. See "Route management".

6. Select an available route.

The screen confirms that the machine is ready to learn the new route.

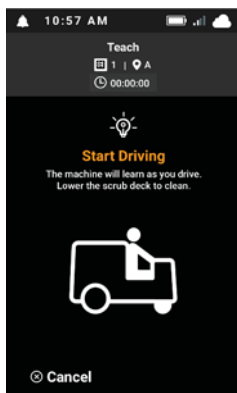

Figure 39: Machine is ready to learn the route

7. To engage the cleaning components, press the One-Touch button.



Figure 40: Press the One-Touch button

The scrub brushes or pads and squeegees lower, and the vacuum turns on. The indicator light above the One-Touch button illuminates.

NOTE: If the One-Touch button or vacuum button is not pressed, the route saves with no cleaning components engaged. Cleaning components cannot be added to the route later.

Autonomous Operation

8. Select the preferred cleaning setting using the solution flow control.



Figure 41: Set the solution flow control

NOTE: Because cleaning requirements can change from day to day, the machine does not record the settings of the flow controls or the brush pressure control.

9. Set the direction switch for the forward direction.

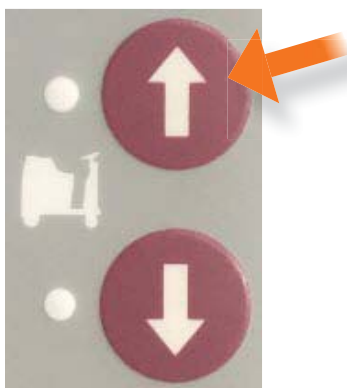

Figure 42: Select the forward direction

NOTE: The machine only cleans when moving forward. Any attempt to clean in reverse causes the route to fail.

10. Press the accelerator pedal and drive the machine through the entire cleaning route. Similar to an automobile, the speed is proportional to the force applied to the pedal; light is slower, and heavy is faster.

After driving begins, the screen confirms that the machine is learning the new route and displays the elapsed time.

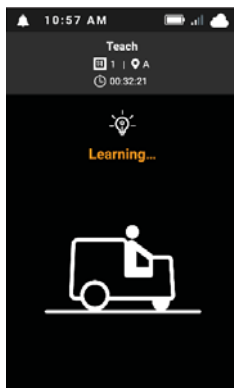

Figure 43: Learning the new route

NOTE: When teaching a new route that includes a non-scrubbable area, press the One-Touch button to raise the scrub brush and squeegees approximately 10 ft (3 m) before reaching the area. Drive past the non-scrubbable area and press the One-Touch button again to lower the scrub brush and squeegees. The BrainOS navigation software remembers where in the route the cleaning components were lifted and lowered during autonomous operation.

11. If driving stops, the screen displays the Learning Paused message.
 - a. To continue the route, resume driving.
 - b. To cancel the route, select Cancel.

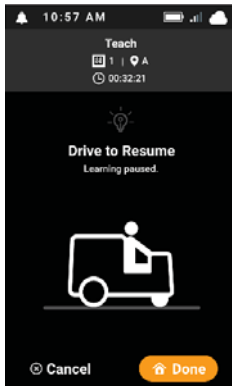

Figure 44: Route learning paused

12. When the route is complete, drive to the same Home Marker scanned at the beginning of the route.
The machine scans the Home Marker.



Figure 45: Scanning the Home Marker

NOTE: A new route cannot be saved until the machine scans the same Home Marker in the same physical location a second time. If the machine cannot detect the Home Marker from its rightside camera, the screen displays a “Drive to scan my home location” message.

Autonomous Operation

After a successful Home Marker scan, the machine prompts the operator to save the route.

13. Select Save.

The machine saves the route while it displays the Saving route message.



Figure 46: Saving the route

14. To label the route, select Choose Label.

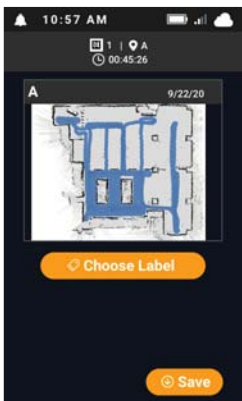

Figure 47: Choose the route label

15. Select a label from the list of available labels, then select Add Label.

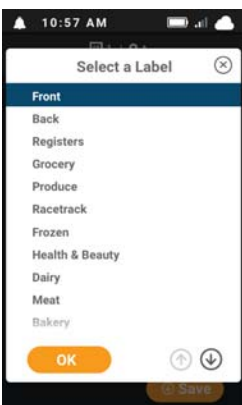

Figure 48: Select an available label

Below is the default list of available route labels.

- Front
- Back
- Registers
- Grocery
- Produce
- Racetrack
- Frozen
- Health & Beauty
- Dairy
- Meat
- Bakery

If your company or facility is interested in custom route labels, contact your Brain Corporation account manager.

16. The machine displays the route with the new label. To save it, select Save. To change the route label, select Edit Label.

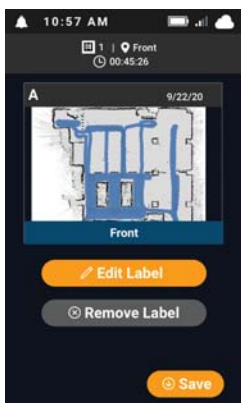

Figure 49: Route displays with the new label

The machine displays the Route saved message.

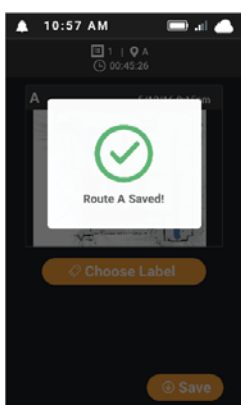

Figure 50: Route saved

Autonomous Operation

NOTE: If the route is saved without a label, the machine assigns it <NO LABEL> by default.

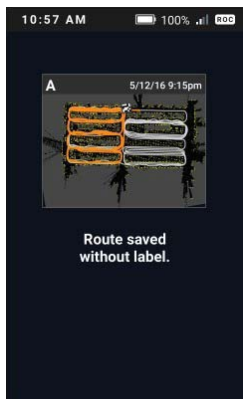

Figure 51: Route saved without a label

17. After teaching a route, test it to make sure that the machine can run the route in autonomous operation successfully. If multiple assists are triggered during the test run, the route might include maneuvers that are difficult for the machine to perform in autonomous operation and must be retaught. See “Run an autonomous route”.

Route management

Each Home Marker supports a maximum of six routes. If all six spaces displayed on the screen are already filled with routes, the operator can only train more routes by deleting one or more of the existing routes associated with that Home Marker.

The operator can also change or remove route labels whenever the machine is not in autonomous mode.

This section describes how to delete a route or edit a route label. For each procedure in this section, follow these steps:

1. To turn on the machine, insert the ignition key and turn to the right (clockwise).
2. Wait for the screen to initialize.
3. Enter the 4-digit PIN (1337) on the screen. Upon successful PIN entry, the screen displays the Main Menu.
4. From the Main Menu, select Settings.



Figure 52: Access the settings

5. Select Routes.

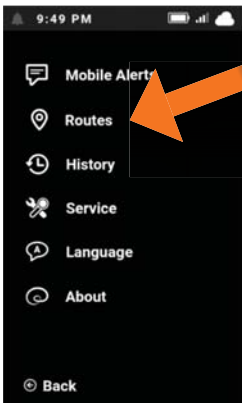

Figure 53: Access the routes

6. Select the applicable Home Marker.



Figure 54: Select the Home Marker

7. Select the route to delete or edit.



Figure 55: Select the route to delete or edit

Autonomous Operation

8. Select the applicable procedure:
 - a. “Delete a route”
 - b. “Change a route label”
 - c. “Remove a route label”

Delete a route

To delete a route from the machine and free up memory space for a new route, follow these steps:

1. To delete the selected route, select Delete Route.

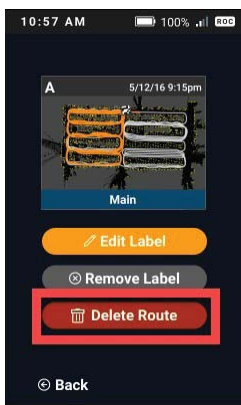

Figure 56: Delete the route

2. To confirm the permanent deletion, select Delete.

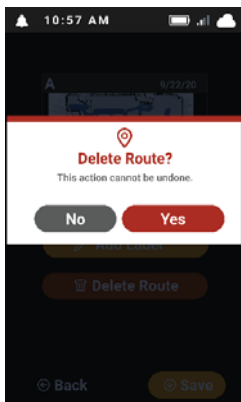

Figure 57: Confirm the route deletion

3. To return to the Main Menu, select Back four times.

Change a route label

NOTE: Although the BrainOS software no longer supports letter designations A–F for routes, the machine can still run older routes with letter designations in autonomous operation. The operator can change any route label—if the machine is not currently in autonomous operation— by following this procedure.

To change a route label, follow these steps:

1. Select Edit Label.

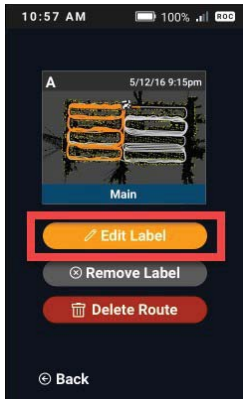

Figure 58: Change the route label

2. Select the new route label from the list of available labels.

Below is the default list of available route labels.

- Front
- Back
- Registers
- Grocery
- Produce
- Racetrack
- Frozen
- Health & Beauty
- Dairy
- Meat
- Bakery

If your company or facility is interested in custom route labels, contact your Brain Corporation account manager.

3. Select Add Label.
4. To return to the Main Menu, select Back four times.

Autonomous Operation

Remove a route label

To remove a route label, follow these steps:

1. Select Remove Label.

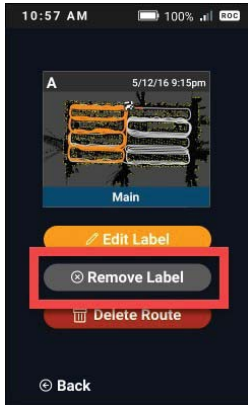

Figure 60: Remove the route label

NOTE: If the route is saved without a label, the machine assigns it <NO LABEL> by default.

2. To return to the Main Menu, select Back four times.

Run an autonomous route

This section describes how to configure the machine to run an existing route in autonomous operation.

Best practices when running a route



WARNING: Do not attempt to ride on the machine, use the steering wheel, or put hands or arms through the steering wheel when the machine is running a route in autonomous mode. The steering wheel can move rapidly and unexpectedly, which could cause physical injuries and disrupt machine operations.

- The operator seat and steering wheel have joyride sensors. If someone sits on the seat or holds the steering wheel while the machine is in autonomous operation, the BrainOS software automatically stops the machine and triggers an alert.
- Pair a mobile device with the machine to receive text messages regarding alerts and cleaning complete notifications. See "Pair a mobile device with the ROC".
- Monitor the side and rear squeegees during the first minute of running the route to ensure that they are properly adjusted.
- Whenever possible, run routes when the area is most free of people and obstacles.
- Prepare the route by removing obstructions such as boxes, protruding merchandise, rugs, and mats.
- Visually inspect all sensors and wipe them down with a dry microfiber cloth before starting an autonomous route. Dirty sensors can affect the machine's performance. Do not apply any water or cleaning solution to the cloth.
- If applicable, visually inspect the machine to ensure there are no items hanging off of it that could trigger the side sensors.

Autonomous Operation

- Test all routes to ensure the machine can run them successfully. Monitor the machine from the back during testing and note any areas of difficulty.
- Monitor the side and rear squeegees or the machine during the first minute of running the route to ensure that they are properly adjusted.
- At the start of a route, do not crowd the front of the machine. This could cause the machine to be unable to recognize the environment.
- The machine requires more space when running autonomously. See the operational manual for the machine for the exact clearance specifications.
- If the machine calls for frequent assists when running the route, assess the environment and remove any obstructions. If the assists persist after obstructions are removed, the route could include maneuvers that the machine cannot replicate autonomously or there could be an environmental factor such as reflection; the route might need to be retaught.
- Environmental considerations can vary, depending on the type of location. For more information, see the BrainOS-Powered Floor Scrubber Process Guide (139-00113-01).

NOTE: Test each new route for trouble-free operation before using the route for daily cleaning.

Run one or more routes

To run one or more autonomous routes, follow these steps:

1. Sit in the operator seat.
2. To turn on the machine, insert the ignition key and turn to the right (clockwise).
3. Wait for the screen to initialize.
4. Enter the 4-digit PIN (1337) on the screen. Upon successful PIN entry, the screen displays the Main Menu.
5. From the Main Menu, select Clean.



Figure 61: Run one or more existing routes

Autonomous Operation

6. Drive the machine to the applicable Home Marker.



Figure 62: Scanning the Home Marker

The machine briefly displays the scanning success message.

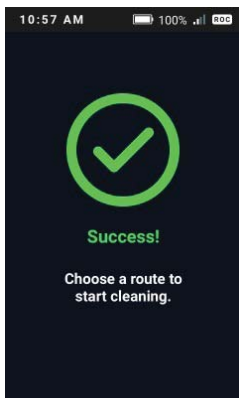

Figure 63: Successful Home Marker scan

The machine displays the available routes associated with the Home Marker.



Figure 64: Available routes displayed

7. Select one to six existing routes from the menu in the preferred order. The figure below shows four routes selected, and the number in the right corner of each shows the order in which each route is scheduled to run.



Figure 65: Select one to six routes

8. To deselect a route, select the route again. The number in the upper right corner clears. In the figure below, the Pharmacy route—previously the third route—is no longer selected.



Figure 66: Pharmacy route deselected

9. Select the route again or select another route, as applicable. In the figure below, the Pharmacy route is now scheduled to run fourth.



Figure 67: Pharmacy route now scheduled to run fourth

Autonomous Operation

10. When the route selections are complete, select Run.
11. Configure the required cleaning settings for the machine, such as water flow control and brush pressure. For details, see the operational manual for the machine.
12. Without turning the key, remove it from the ignition to help prevent it from being lost.
13. Step off the machine.
14. If the machine has safety straps, secure them to block access to the operator seat.
15. Push the Start/Pause button.



Figure 68: Start the route

The yellow warning light flashes and the horn momentarily sounds as a warning that autonomous operation is starting. The screen displays the Cleaning In Progress message.

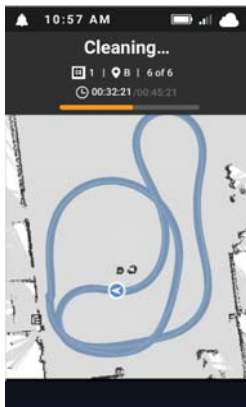

Figure 69: Cleaning in progress

The screen is disabled while the machine is in autonomous operation. Touching the screen during this time results in the Screen Disabled message but does not halt operations.

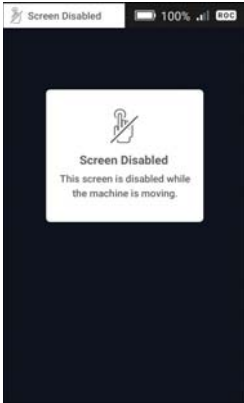

Figure 70: Screen disabled in autonomous operation.

16. Make sure that the machine is performing correctly. If anything requires adjustment, press the Start/Pause button and reconfigure the cleaning settings. To resume the route, press the Start/Pause button again.



Figure 71: Route paused

17. If the machine is paired with a mobile device, the mobile device receives route cleaning status updates as each route completes.



Figure 72: Mobile device route cleaning status updates

Autonomous Operation

18. If the mobile device receives an assist message, locate the machine and attempt to resolve the assist. For more information, see the OEM BrainOS Error Code Reference (150-00038-02).
19. When the cleaning routes are complete, enter the 4-digit PIN (1337) to access the machine.



Figure 73: Enter the security PIN

The screen shows areas cleaned in orange, and areas not cleaned in white. How much of the route was actually cleaned depends on whether the cleaning components were engaged or not while teaching the routes.



Figure 74: Cleaning is complete

20. To view the history for additional routes, select the left or right arrows, as applicable.
21. When finished viewing, select Done.

Cancel a route

To cancel an active cleaning route, follow these steps:

1. Press the Start/Pause button.
 - a. To resume the route, press the Start/Pause button.
 - b. To cancel the route, select Cancel Route.



Figure 75: Cancel the route

NOTE: Canceling a route only stops the machine from running the route at the present time. It does not delete the route from the machine.

Autonomous Operation

Manually stop the machine

While in autonomous operation, it might be necessary to stop the machine using the Start/Pause button for any number of reasons. Whenever possible, press this button instead of the Emergency Stop button, unless the machine is about to run into a person or an obstacle.

The machine can automatically pause itself when an assist is triggered. For more information regarding assists, see the OEM BrainOS Error Code Reference (150-00038-02).

To pause autonomous operation, follow these steps:

1. To pause the machine, press the Start/Pause button.



Figure 76: Route paused

2. Make any necessary adjustments to the machine configuration or environment.
3. Perform one of the following steps:
 - a. To resume the autonomous route, press the Start/Pause button.
 - b. To cancel the autonomous route, select Cancel Route.



WARNING: When stopped during a route, the machine could release any fluids that have not yet reached the recovery tank. To avoid a potential fall hazard, mop up any standing fluids.

Emergency Stop the machine

The Emergency Stop button removes the power from all motors. To cancel a route using the Emergency Stop button, follow these steps:

1. Press the Emergency Stop button.

The turn signals and the control panel lights flash. The screen displays the Emergency Stop message.



Figure 77: Emergency Stop button pressed

2. Inspect the surrounding environment and the machine itself.



WARNING: When stopped during a route, the machine could release any fluids that have not yet reached the recovery tank. To avoid a potential fall hazard, mop up any standing fluids.

3. Remove any obstacles that can be moved, or drive the machine around the obstacle.
4. To release the Emergency Stop, twist the button clockwise (to the right).
5. To confirm that the environmental/machine issues have been resolved, select Confirm.

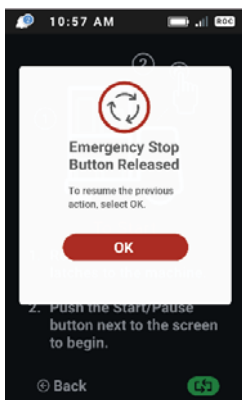

Figure 78: Emergency Stop button released

6. To resume autonomous operation, press the Start/Pause button.

Autonomous Operation

Respond to notifications

For information regarding notifications—including a complete listing of all error codes—see the OEM BrainOS Error Code Reference (150-00038-02).

Access the route history

The route history shows the duration of each route and the overall route coverage for any routes run over the past seven days. This feature shows what areas of the route were cleaned autonomously by the machine (and which areas were not cleaned). It can be used by both operators and supervisors to ensure that the route was utilized properly.

To access the route history of the machine for the past week, follow these steps:

1. To turn on the machine, insert the ignition key and turn to the right (clockwise).
2. Wait for the screen to initialize.
3. Enter the 4-digit PIN (1337) on the screen. Upon successful PIN entry, the screen displays the Main Menu.
4. From the Main menu, select Settings.



Figure 79: Select the Settings menu

5. Select HISTORY.

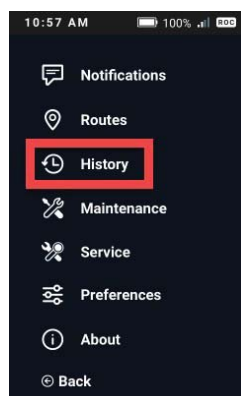

Figure 80: Select the History menu

The Weekly History screen displays the time of day and runtime for each route.

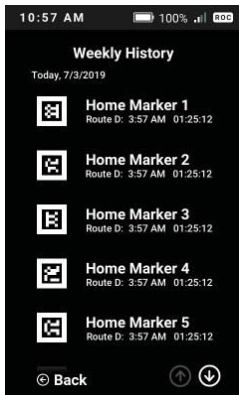

Figure 81: Weekly History

6. Select a route from the list.
 - Scroll up or down to see more routes by selecting the up or down arrows at the bottom of the screen.
 - Collapse or expand routes for a day by selecting that day.
7. View the results of the History screen:
 - Orange shows the route taken by the machine. How much of the route was actually cleaned depends on whether the cleaning components were engaged or not while teaching the route.
 - White shows the area that was in the trained route, but was not cleaned.

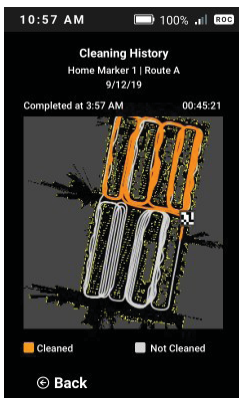

Figure 82: Cleaning History for the selected route

Autonomous Operation

Alerts during operation

The screen displays a message if an alert occurs. Alerts can occur during manual or autonomous operation. If an alert occurs during autonomous operation, the BrainOS software automatically pauses the machine. The screen displays the details of the triggered alert with steps to resolve the issue. When a mobile device is paired to the ROC to receive notifications, a text message of the alert is sent to the paired mobile device. If necessary, the machine can be manually driven when an alert has been triggered, but all scrubbing functions are disabled.



Figure 83: Sample alert message (the water tank is empty)

Error codes and warnings

Table 6 lists some possible error conditions and the steps required to resolve them. For the complete list of error codes and warnings, see the OEM BrainOS Error Code Reference (15000038-02), which lists the following error code types:

- Alerts
- Assists
- Errors
- Startup errors
- Kinetek controller error codes

Table 6: Alerts during operation

Alert	Cause	Resolution Steps
Recovery Tank Full	The recovery tank is full.	<ol style="list-style-type: none"> 1. Drain the recovery tank. 2. Drive the machine back to the path. 3. To resume, press the Start/Pause button.
Water Tank Empty	The clean water tank is empty.	<ol style="list-style-type: none"> 1. Fill the water tank. 2. Drive the machine back to the path. 3. To resume, press the Start/Pause button.
Battery Low	The batteries must be charged.	<ol style="list-style-type: none"> 1. Drive the machine to the charging station. 2. Turn off the machine. 3. Charge the batteries.
Sensor Error	The sensors are dirty or damaged.	<ol style="list-style-type: none"> 1. Clean the sensors with a clean microfiber cloth. 2. Inspect for damage. 3. Restart the machine.
Seat Sensor Triggered	A person or object is in the seat during autonomous operation.	<ol style="list-style-type: none"> 1. Make sure the seat is empty. 2. To resume, press the Start/Pause button.
Path is Blocked	One or more obstacles is on the cleaning route.	<ol style="list-style-type: none"> 1. Make sure the path is clear. 2. Drive past any obstacles. 3. To resume, press the Start/Pause button.
Machine is Off Path	The machine is off the autonomous route.	<ol style="list-style-type: none"> 1. Follow the arrow and drive the machine to the highlighted path. 2. When correct, the path turns white. 3. To resume, press the Start/Pause button.

Autonomous Operation

Alert	Cause	Resolution Steps
Impact Detected	The machine bumped an obstacle on the cleaning route.	<ol style="list-style-type: none"> 1. Inspect the machine and the surrounding area. 2. Drive past any obstacles. 3. If clear, press the Start/Pause button to resume.
Machine Error	Possible steering wheel obstruction	<ol style="list-style-type: none"> 1. Make sure the path is clear. 2. Drive past any obstacles. 3. To resume, press the Start/Pause button.
Unknown Error	Error(s) of unknown origin	<ol style="list-style-type: none"> 1. Restart the machine. 2. If the issue continues, contact customer service.
Traction Motor Error	Acceleration issues	<ol style="list-style-type: none"> 1. Turn off the machine. 2. Disconnect the battery cable for 15 seconds. 3. Reconnect the cable and turn on the machine. 4. If the issue continues, contact customer service.
Brush Error	Debris caught in brush or brush is damaged	<ol style="list-style-type: none"> 1. Inspect the brushes and pads for damage or debris. 2. Adjust or replace as needed. 3. If no issues are found, press the Start/Pause button to resume. 4. If the issue continues, contact customer service.
Vacuum Error	Vacuum hose obstructed or damaged	<ol style="list-style-type: none"> 1. Inspect the vacuum and hose for damage or debris. 2. If the hose is clear, press the Start/Pause button to resume. 3. If the hose is broken, contact customer service.
Squeegee Error	Squeegee is obstructed, damaged, or missing	<ol style="list-style-type: none"> 1. Inspect the squeegee for damage or debris. 2. Adjust or replace as needed. 3. If the issue continues, contact customer service.

Autonomous Operation

Alert	Cause	Resolution Steps
Scrub Deck Error	Scrub deck obstruction is preventing raising/lowering	<ol style="list-style-type: none">1. Turn off the machine.2. Inspect the scrub deck for damage.3. Turn on the machine.4. If the issue continues or damage is detected, contact customer service.
No Brush Detected	Scrub brush or pad is missing or is improperly installed	<ol style="list-style-type: none">1. Make sure brushes or pads are properly installed. If2. No issues are found, press the Start/Pause button to resume.3. If the issue persists, contact customer service.

After use daily tasks

When you are finished using your Scrubmaster AMR, perform the following recommended daily tasks to clean and store the Scrubmaster AMR.

Drain and clean tanks, hoses, and filters

1. Disengage all cleaning components by pressing the one-touch button, if needed. Doing so will raise the scrub brush and squeegee, as well as turn off the vacuum motor.
2. Using appropriate personal protective equipment, drain the recovery tank using the recovery tank drain hose located on the rear left of the Scrubmaster AMR.
3. Using appropriate personal protective equipment, clean out the recovery tank and its internal screened float of any remaining debris by flushing with water and/or wiping clean.
4. Using appropriate personal protective equipment, drain the solution tank using the solution tank site gauge/drain hose located on the rear right of the Scrubmaster AMR.
5. Rinse the solution tank with clean water to prevent chemical buildup and clogging of water lines.
6. Remove the solution fill filter from the solution fill port on the rear, top left side of the Scrubmaster AMR and rinse with clean water.

Clean scrub brush/pad

1. Unload and remove the scrub brush or pad. See INSTALL SCRUB BRUSH/PAD for details.
2. Remove any wire, string, or twine wrapped around the brush/pad.
3. Rinse with warm water.
4. Hang to dry.

Clean squeegee

Check the squeegee daily, and clean as necessary. Perform the following steps to clean:

1. Remove the squeegee: See INSTALL AND ADJUST SQUEEGEE for details.
2. Rinse with warm water.
3. Wipe clean.
4. Reinstall.

Clean in-line solution filter

The solution solenoid, which shuts off solution flow, is protected from debris by the in-line filter assembly located on the under-carriage of the Scrubmaster AMR on the left-hand side, just under the solution tank. It is important to check and clean the screened washer inside the assembly regularly to ensure proper solution flow. Perform these steps to access and clean the screened washer:

1. Lift the scrub deck, if necessary.
2. On the under-carriage of the Scrubmaster AMR, pull the blue shut-off handle (shown below) to the closed position.
3. Unscrew the screen assembly (shown below).
4. Remove the screen and rinse.
5. Once clean, reinsert the screen.
6. Screw the assembly together, tightening by hand.
 - a. Over-tightening with tools may damage the plastic threads.

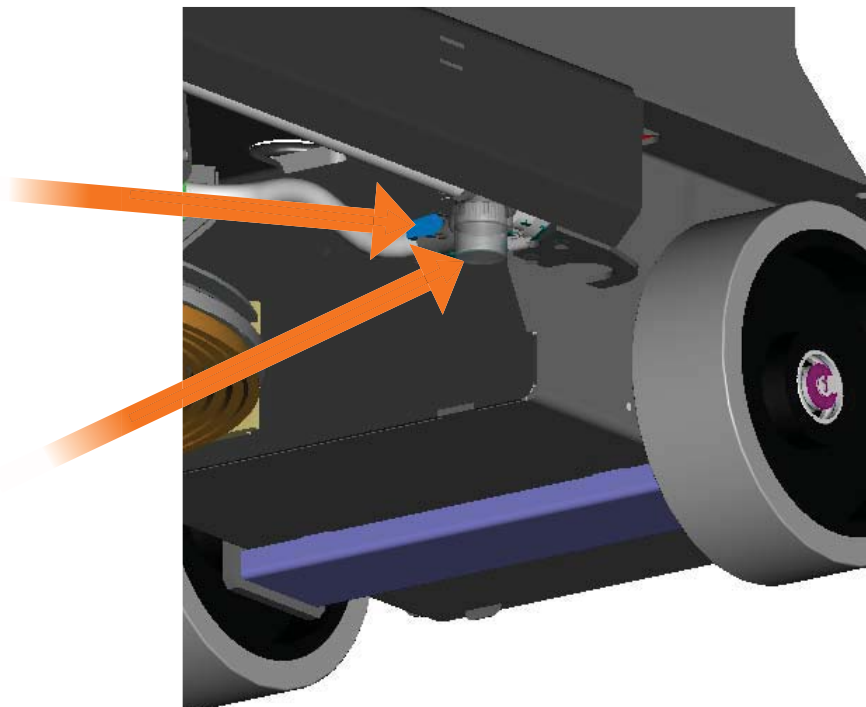

After Use

Clean the sensors

Because autonomous operation relies on LIDAR sensors, 2D cameras, and 3D cameras, it is imperative to keep them clean and free from damage. Debris, streaks, or smudges can prohibit the ability of the machine to run in autonomous operation. Clean all sensors using the provided microfiber cloth, and inspect each sensor and camera for damage, such as scratches or cracks.



Figure 94: Upper LIDAR sensor

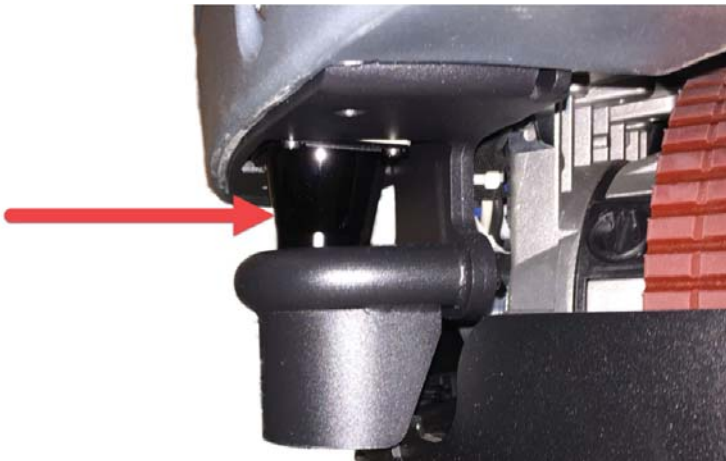

Figure 95: Lower LIDAR sensor

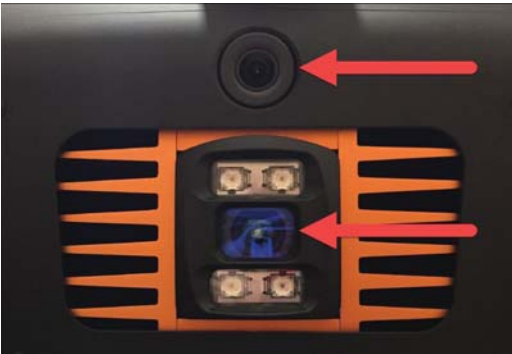

Figure 96: Front 2D and 3D cameras

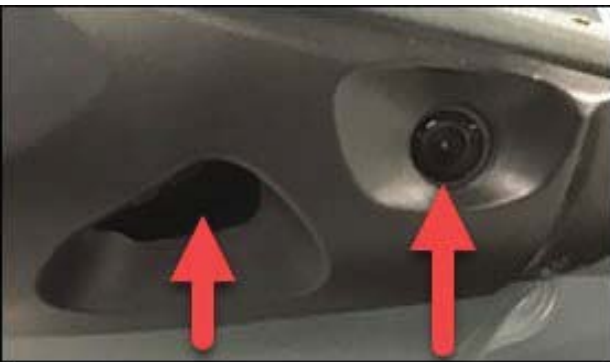

Figure 97: Left side 2D and 3D cameras



Figure 98: Right side 2D and 3D cameras

After Use

Park and power down

When not in use, the Scrubmaster AMR should be stored in a designated parking station. Turning off and securing the Scrubmaster AMR is vital. Turn the ignition key to the left (counter-clockwise) to turn off the Scrubmaster AMR. Remove the key to prevent unauthorized use.

NOTE: Always park the Scrubmaster AMR away from stairways, fire doors, and fire equipment.

Scrubmaster AMR storage

1. Always store in a designated parking station that is secured from public access.
2. Always store indoors.
3. Always store in a dry area.
4. Always store in its upright position.
5. Always store with the pad driver/brush raised off the floor.
6. Always store with the rear and side squeegee assemblies raised off the floor.
7. Drain all fluids from the clean water tank, recovery tank, and solution bottle; especially if storing in an area which may reach freezing temperatures. Any damage caused by freezing temperatures will not be covered by the warranty.



Battery charging

The Scrubmaster AMR's battery is designed to last up to 3 – 3.5 hours on the lowest solution flow control setting when using the recommended AGM batteries. Charge the batteries when the Scrubmaster AMR is not in operation.

Dispose of components such as batteries, hazardous fluids such as antifreeze, and oil in an environmentally safe way according to local waste disposal regulations.

NOTE: The machine cannot operate when charging.

Perform the following steps to charge the batteries:

1. Place the Scrubmaster AMR in a well-ventilated area.
2. Turn off the Scrubmaster AMR.
3. Remove the battery compartment cover.
4. Unwind the power supply cord and insert into a properly grounded receptacle.
5. The battery charge Indicator will turn red to indicate charging. Once charging is complete, this indicator turns green.
6. When charging is complete, disconnect the power supply cord and wind up to the right of the batteries accordingly.
7. Place the battery compartment cover back into position.



Brake Release

Brake release procedure

The Scrubmaster AMR is stopped via an electromagnetic brake, located on the front drive wheel assembly. When the accelerator pedal is pressed the electromagnetic brake releases, which allows the Scrubmaster AMR to move forward or backward. When pressure is removed from the accelerator pedal, the electromagnetic brake presses against the front drive wheel to stop the Scrubmaster AMR.

If the Scrubmaster AMR is inoperable or immobile, it can be manually moved by releasing the electromagnetic brake by performing the following steps:

1. Turn the Scrubmaster AMR off using the ignition key.
2. Locate the electromagnetic brake on the front drive wheel assembly.
3. Place a small, flathead screwdriver between the wheel and the brake release lever. This will bypass the electromagnetic brake.
4. Slowly push the Scrubmaster AMR to a safe location where it can remain until a service technician arrives to perform repairs.
5. Once you have moved the Scrubmaster AMR to a safe place, remove the screwdriver from the front drive wheel assembly to activate the electromagnetic brake.



Troubleshooting tips

Problem	Cause	Resolution
Poor or no water pick-up	Worn or torn squeegee blade	Rotate or replace blade
	Recovery tank full	Empty recovery tank
	Recovery tank drain hose leak	Secure drain hose cap or replace
	Recovery tank lid gasket leak	Replace gasket lid cover properly
	Debris caught in squeegee	Clean squeegee
	Vacuum hose or squeegee outlet clogged	Remove debris and flush hose
	Using too much solution	Adjust solution flow setting
	Recovery hose to squeegee or recovery tank disconnected or damaged	Reconnect or replace recovery hose
Poor scrubbing performance	Worn brushes	Rotate or replace brushes
	Wrong brush or cleaning chemical	Consult PowerBoss
	Debris caught on scrub brushes	Remove debris
	Moving machine too fast	Slow down
	Not using enough solution	Adjust solution flow setting
	Low battery charge	Recharge batteries
Inadequate solution flow or no solution to the floor	Solution tank empty	Fill solution tank
	Solution lines, valves, filter, or spray jets clogged	Flush lines and clean solution filter and spray jets
	Scrub deck raised	Press the one-touch button to lower scrub deck

Troubleshooting & Support

Problem	Cause	Resolution
Machine not operational	Tripped Control Power circuit breaker	Reset breaker
	Low battery charge	Recharge batteries
	Battery charger operating	Unplug battery charger when charge is complete
Vacuum motor does not turn on	Recovery tank full	Empty recovery tank
	Excessive foaming in recovery tank	Empty recovery tank Use a different cleaning chemical Use a lesser amount of the cleaning chemical Use a defoaming agent
	Carbon brushes worn	Replace carbon brushes
	Vacuum switch disconnected	Connect wiring
	Vacuum not turned on	Press vacuum button
No power to machine	Battery Disconnected	Check All Battery Cable Connections
	Emergency Shut-Off Activated	Reset
	Battery Terminals Corroded	Clean Connections
	Faulty Main Connector	Replace Connector
	Faulty Key Switch	Replace Switch
Brush does not unload	Broken brush motor switch	Replace switch
	Damaged brush block or drive hub	Replace
	Scrub deck not all the way up	Push the one-touch button and wait for the scrub deck to completely raise
No ROC connection	Poor cellular signal	Turn the machine off, wait 10 seconds, and turn back on

Maintenance schedule

Frequency	Responsibility	Task description
Daily	Operator	Drain and clean the recovery tank, filter, float sensor, and yellow strainer basket.
	Operator	Drain and rinse the clean water tank and float sensor.
	Operator	Check the rear and side squeegees for deflection, leveling, and wear. Rotate or replace as needed.
	Operator	Check the scrub brush or pad for debris, damage, and wear.
	Operator	Clean the front and side 2D and 3D cameras with provided microfiber cloth. Check for damage.
	Operator	Clean the upper and lower LIDAR sensors with provided microfiber cloth. Check for damage.
Weekly	Operator	Check the front and side perimeter skirts for debris, damage, and wear.
Monthly	Operator	Check the recovery tank seal for damage and wear.
	Operator	Check the solution tank seal for damage and wear.
	Operator	Check the batteries and clean tops to prevent corrosion.
	Operator	Check for loose battery cable connections.
	Operator	Check all tanks and hoses for leaks.
	Operator	Check the machine for loose nuts and bolts.
	Technician	Lubricate all grease points and pivot points with silicon spray and approved grease.
250 Hours	Technician	Check the motor brushes and replace as needed.
350 Hours	Technician	Check the front and rear tires for damage and wear.

Maintenance & Support

Where to get maintenance and support

If the touch screen displays the following error, reboot the Scrubmaster AMR. If the problem persists, please contact customer service.

Customer Support

(800) 323 - 9420

techsupport@PowerBossintl.com

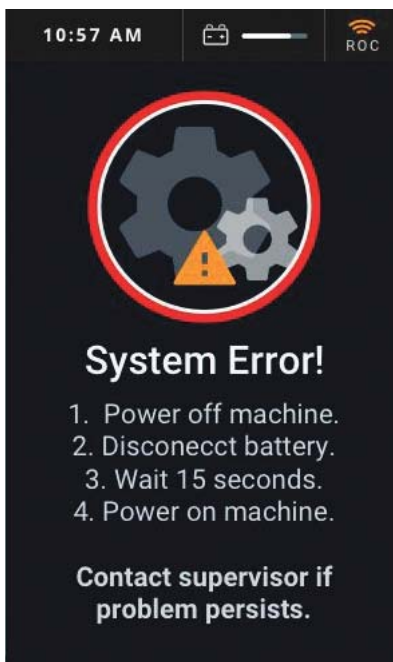

PowerBoss[®]

The Power of Clean

14N845 U.S. Route 20
Pingree Grove, Illinois 60140 USA
(800) 323-9420
www.powerboss.com
A Member of the Hako Group

